

Set 8:

Inference in First-order logic

ICS 271 Fall 2012

Chapter 9: Russell and Norvig

Outline

- ◇ Reducing first-order inference to propositional inference
- ◇ Unification
- ◇ Generalized Modus Ponens
- ◇ Forward and backward chaining
- ◇ Logic programming
- ◇ Resolution

Universal instantiation (UI)

- Every instantiation of a universally quantified sentence is entailed by it:

$$\frac{\forall v \alpha}{\text{Subst}(\{v/g\}, \alpha)}$$

for any variable v and ground term g

- E.g., $\forall x \text{ King}(x) \wedge \text{Greedy}(x) \Rightarrow \text{Evil}(x)$ yields:

$\text{King}(\text{John}) \wedge \text{Greedy}(\text{John}) \Rightarrow \text{Evil}(\text{John})$

$\text{King}(\text{Richard}) \wedge \text{Greedy}(\text{Richard}) \Rightarrow \text{Evil}(\text{Richard})$

$\text{King}(\text{Father}(\text{John})) \wedge \text{Greedy}(\text{Father}(\text{John})) \Rightarrow \text{Evil}(\text{Father}(\text{John}))$

.

- Obtained by substituting $\{x/\text{John}\}$, $\{x/\text{Richard}\}$ and $\{x/\text{Father}(\text{John})\}$

.

Existential instantiation (EI)

- For any sentence α , variable v , and constant symbol k that does **not** appear elsewhere in the knowledge base:

$$\frac{\exists v \alpha}{\text{Subst}(\{v/k\}, \alpha)}$$

- E.g., $\exists x \text{Crown}(x) \wedge \text{OnHead}(x, \text{John})$ yields:

$$\text{Crown}(C_1) \wedge \text{OnHead}(C_1, \text{John})$$

provided C_1 is a new constant symbol, called a **Skolem constant**

Reduction to propositional inference

Suppose the KB contains just the following:

$\forall x \text{ King}(x) \wedge \text{Greedy}(x) \Rightarrow \text{Evil}(x)$
King(John)
Greedy(John)
Brother(Richard,John)

- Instantiating the universal sentence in **all possible** ways, we have:
King(John) \wedge Greedy(John) \Rightarrow Evil(John)
King(Richard) \wedge Greedy(Richard) \Rightarrow Evil(Richard)
King(John)
Greedy(John)
Brother(Richard,John)
- The new KB is **propositionalized**: proposition symbols are

King(John), Greedy(John), Evil(John), King(Richard), etc.

Reduction contd.

- Every FOL KB can be propositionalized so as to preserve entailment
- (A ground sentence is entailed by new KB iff entailed by original KB)
- **Idea:** propositionalize KB and query, apply resolution, return result
- **Problem:** with function symbols, there are infinitely many ground terms,
 - e.g., *Father(Father(Father(John)))*

Reduction contd.

Theorem: Herbrand (1930). If a sentence α is entailed by an FOL KB, it is entailed by a **finite** subset of the propositionalized KB

Idea: For $n = 0$ to ∞ do
 create a propositional KB by instantiating with depth- n terms
 see if α is entailed by this KB

Problem: works if α is entailed, loops if α is not entailed

Theorem: Turing (1936), Church (1936) Entailment for FOL is **semidecidable** (algorithms exist that say yes to every entailed sentence, but no algorithm exists that also says no to every nonentailed sentence.)

Problems with propositionalization

- Propositionalization seems to generate lots of irrelevant sentences.

- E.g., from:

$\forall x \text{ King}(x) \wedge \text{Greedy}(x) \Rightarrow \text{Evil}(x)$

$\text{King}(\text{John})$

$\forall y \text{ Greedy}(y)$

$\text{Brother}(\text{Richard}, \text{John})$

- Given query “evil(x) it seems obvious that *Evil(John)*, but propositionalization produces lots of facts such as *Greedy(Richard)* that are irrelevant
- With p k -ary predicates and n constants, there are $p \cdot n^k$ instantiations.

Generalized Modus Ponens (GMP)

$$\frac{p_1', p_2', \dots, p_n', (p_1 \wedge p_2 \wedge \dots \wedge p_n \Rightarrow q)}{q\theta} \quad \text{where } p_i'\theta = p_i \theta \text{ for all } i$$

p_1' is *King(John)*

p_1 is *King(x)*

p_2' is *Greedy(y)*

p_2 is *Greedy(x)*

θ is $\{x/\text{John}, y/\text{John}\}$

q is *Evil(x)*

$q \theta$ is *Evil(John)*

- GMP used with KB of **definite clauses** (**exactly** one positive literal)
- All variables assumed universally quantified

Soundness of GMP

- Need to show that

$$p_1', \dots, p_n', (p_1 \wedge \dots \wedge p_n \Rightarrow q) \vDash q\theta$$

provided that $p_i'\theta = p_i\theta$ for all i

- Lemma: For any sentence p , we have $p \vDash p\theta$ by UI

1. $(p_1 \wedge \dots \wedge p_n \Rightarrow q) \vDash (p_1 \wedge \dots \wedge p_n \Rightarrow q)\theta = (p_1\theta \wedge \dots \wedge p_n\theta \Rightarrow q\theta)$
2. $p_1', \dots, p_n' \vDash p_1' \wedge \dots \wedge p_n' \vDash p_1'\theta \wedge \dots \wedge p_n'\theta$
3. From 1 and 2, $q\theta$ follows by ordinary Modus Ponens

Unification

- We can get the inference immediately if we can find a substitution θ such that $King(x)$ and $Greedy(x)$ match $King(John)$ and $Greedy(y)$

$\theta = \{x/John, y/John\}$ works

- $Unify(\alpha, \beta) = \theta$ if $\alpha\theta = \beta\theta$

p	q	θ
Knows(John,x)	Knows(John,Jane)	
Knows(John,x)	Knows(y,OJ)	
Knows(John,x)	Knows(y,Mother(y))	
Knows(John,x)	Knows(x,OJ)	

Unification

- We can get the inference immediately if we can find a substitution θ such that $King(x)$ and $Greedy(x)$ match $King(John)$ and $Greedy(y)$

$\theta = \{x/John, y/John\}$ works

- $Unify(\alpha, \beta) = \theta$ if $\alpha\theta = \beta\theta$

p	q	θ
Knows(John,x)	Knows(John,Jane)	{x/Jane}
Knows(John,x)	Knows(y,OJ)	
Knows(John,x)	Knows(y,Mother(y))	
Knows(John,x)	Knows(x,OJ)	

Unification

- We can get the inference immediately if we can find a substitution θ such that $King(x)$ and $Greedy(x)$ match $King(John)$ and $Greedy(y)$

$\theta = \{x/John, y/John\}$ works

- $Unify(\alpha, \beta) = \theta$ if $\alpha\theta = \beta\theta$

p	q	θ
Knows(John,x)	Knows(John,Jane)	$\{x/Jane\}$
Knows(John,x)	Knows(y,OJ)	$\{x/OJ, y/John\}$
Knows(John,x)	Knows(y,Mother(y))	
Knows(John,x)	Knows(x,OJ)	

- **Standardizing apart** eliminates overlap of variables, e.g., Knows(z_{17} , OJ)

Unification

- We can get the inference immediately if we can find a substitution θ such that $King(x)$ and $Greedy(x)$ match $King(John)$ and $Greedy(y)$

$\theta = \{x/John, y/John\}$ works

- $Unify(\alpha, \beta) = \theta$ if $\alpha\theta = \beta\theta$

p	q	θ
Knows(John,x)	Knows(John,Jane)	$\{x/Jane\}$
Knows(John,x)	Knows(y,OJ)	$\{x/OJ, y/John\}$
Knows(John,x)	Knows(y,Mother(y))	$\{y/John, x/Mother(John)\}$
Knows(John,x)	Knows(x,OJ)	

- Standardizing apart** eliminates overlap of variables, e.g., Knows(z_{17} , OJ)

Unification

- We can get the inference immediately if we can find a substitution θ such that $King(x)$ and $Greedy(x)$ match $King(John)$ and $Greedy(y)$

$\theta = \{x/John, y/John\}$ works

- $Unify(\alpha, \beta) = \theta$ if $\alpha\theta = \beta\theta$

p	q	θ
$Knows(John, x)$	$Knows(John, Jane)$	$\{x/Jane\}$
$Knows(John, x)$	$Knows(y, OJ)$	$\{x/OJ, y/John\}$
$Knows(John, x)$	$Knows(y, Mother(y))$	$\{y/John, x/Mother(John)\}$
$Knows(John, x)$	$Knows(x, OJ)$	$\{fail\}$

Unification

- To unify $Knows(John, x)$ and $Knows(y, z)$,
 $\theta = \{y/John, x/z\}$ or $\theta = \{y/John, x/John, z/John\}$
- The first unifier is **more general** than the second.
- There is a single **most general unifier** (MGU) that is unique up to renaming of variables.
MGU = $\{y/John, x/z\}$

The unification algorithm

function UNIFY(x, y, θ) returns a substitution to make x and y identical

inputs: x , a variable, constant, list, or compound

y , a variable, constant, list, or compound

θ , the substitution built up so far

if $\theta = \text{failure}$ **then return failure**

else if $x = y$ **then return** θ

else if VARIABLE?(x) **then return** UNIFY-VAR(x, y, θ)

else if VARIABLE?(y) **then return** UNIFY-VAR(y, x, θ)

else if COMPOUND?(x) **and** COMPOUND?(y) **then**

return UNIFY(ARGS[x], ARGS[y], UNIFY(OP[x], OP[y], θ))

else if LIST?(x) **and** LIST?(y) **then**

return UNIFY(REST[x], REST[y], UNIFY(FIRST[x], FIRST[y], θ))

else return failure

The unification algorithm

```
function UNIFY-VAR(var, x,  $\theta$ ) returns a substitution
  inputs: var, a variable
            x, any expression
             $\theta$ , the substitution built up so far

  if {var/val}  $\in$   $\theta$  then return UNIFY(val, x,  $\theta$ )
  else if {x/val}  $\in$   $\theta$  then return UNIFY(var, val,  $\theta$ )
  else if OCCUR-CHECK?(var, x) then return failure
  else return add {var/x} to  $\theta$ 
```

Example knowledge base

- The law says that it is a crime for an American to sell weapons to hostile nations. The country Nono, an enemy of America, has some missiles, and all of its missiles were sold to it by Colonel West, who is American.
- Prove that Col. West is a criminal

Example knowledge base, contd.

... it is a crime for an American to sell weapons to hostile nations:

American(x) ∧ Weapon(y) ∧ Sells(x,y,z) ∧ Hostile(z) ⇒ Criminal(x)

Nono ... has some missiles, i.e., $\exists x$ Owns(Nono,x) ∧ Missile(x):

Owns(Nono,M₁) and Missile(M₁)

... all of its missiles were sold to it by Colonel West

Missile(x) ∧ Owns(Nono,x) ⇒ Sells(West,x,Nono)

Missiles are weapons:

Missile(x) ⇒ Weapon(x)

An enemy of America counts as "hostile":

Enemy(x,America) ⇒ Hostile(x)

West, who is American ...

American(West)

The country Nono, an enemy of America ...

Enemy(Nono,America)

Forward chaining algorithm

```
function FOL-FC-ASK( $KB, \alpha$ ) returns a substitution or false
  repeat until new is empty
     $new \leftarrow \{\}$ 
    for each sentence  $r$  in  $KB$  do
       $(p_1 \wedge \dots \wedge p_n \Rightarrow q) \leftarrow \text{STANDARDIZE-APART}(r)$ 
      for each  $\theta$  such that  $(p_1 \wedge \dots \wedge p_n)\theta = (p'_1 \wedge \dots \wedge p'_n)\theta$ 
        for some  $p'_1, \dots, p'_n$  in  $KB$ 
           $q' \leftarrow \text{SUBST}(\theta, q)$ 
          if  $q'$  is not a renaming of a sentence already in  $KB$  or new then do
            add  $q'$  to new
             $\phi \leftarrow \text{UNIFY}(q', \alpha)$ 
            if  $\phi$  is not fail then return  $\phi$ 
    add new to  $KB$ 
  return false
```

Forward chaining proof

American(West)

Missile(M1)

Owns(Nono,M1)

Enemy(Nono,America)

Forward chaining proof

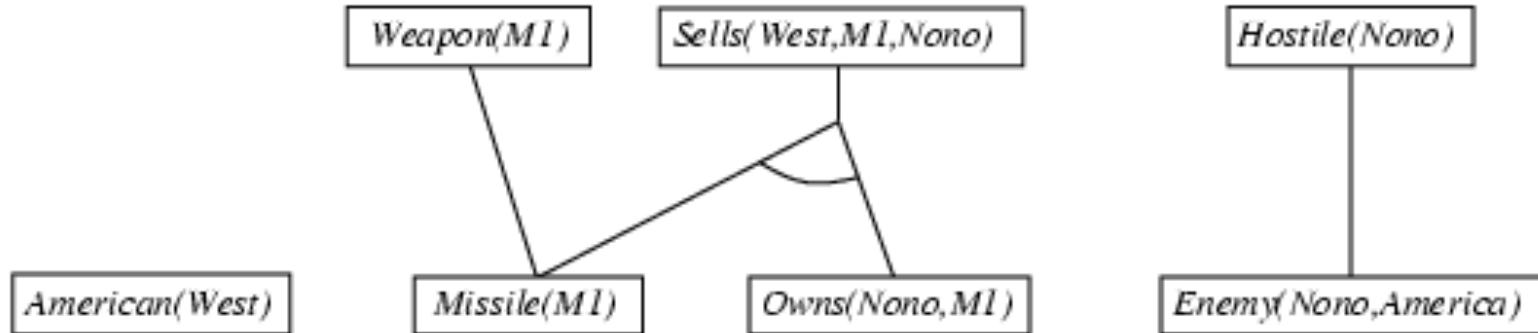

$Enemy(x, America) \Rightarrow Hostile(x)$

$Missile(x) \wedge Owns(Nono, x) \Rightarrow Sells(West, x, Nono)$

$Missile(x) \Rightarrow Weapon(x)$

Forward chaining proof

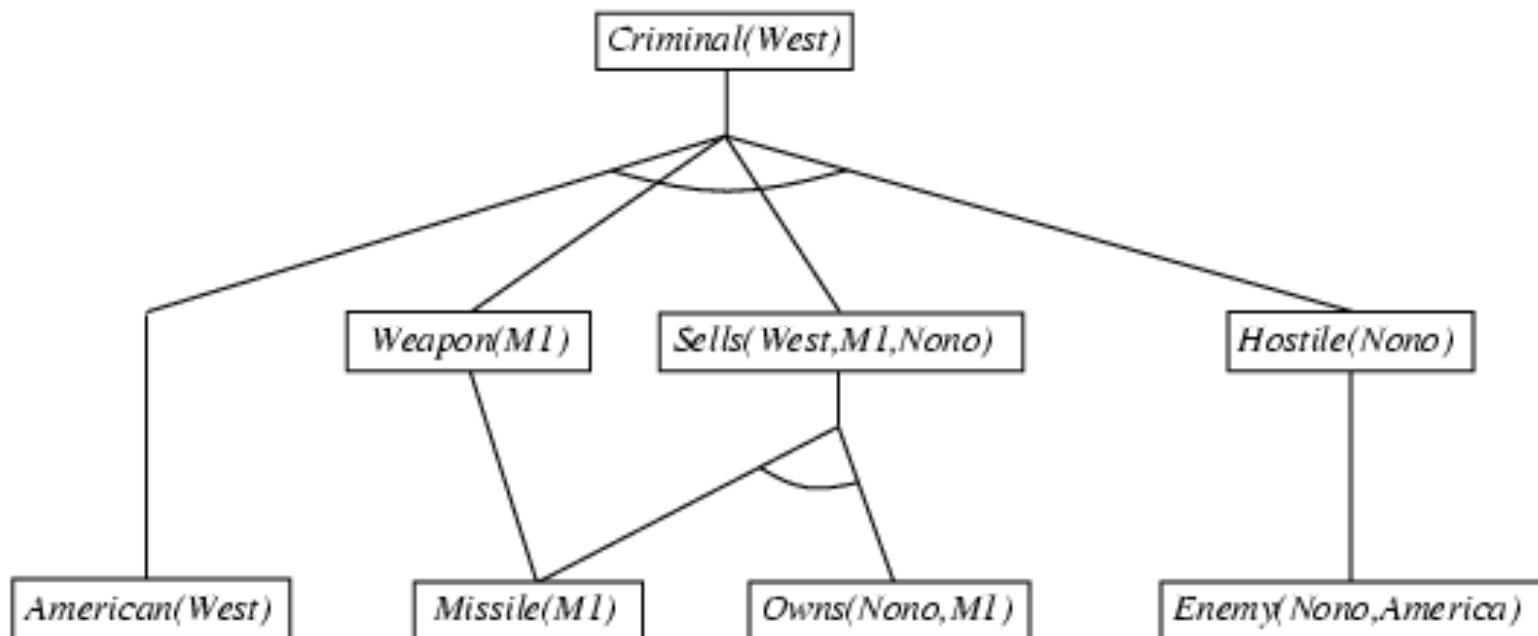

$American(x) \wedge Weapon(y) \wedge Sells(x,y,z) \wedge Hostile(z) \Rightarrow Criminal(x)$

Forward chaining proof

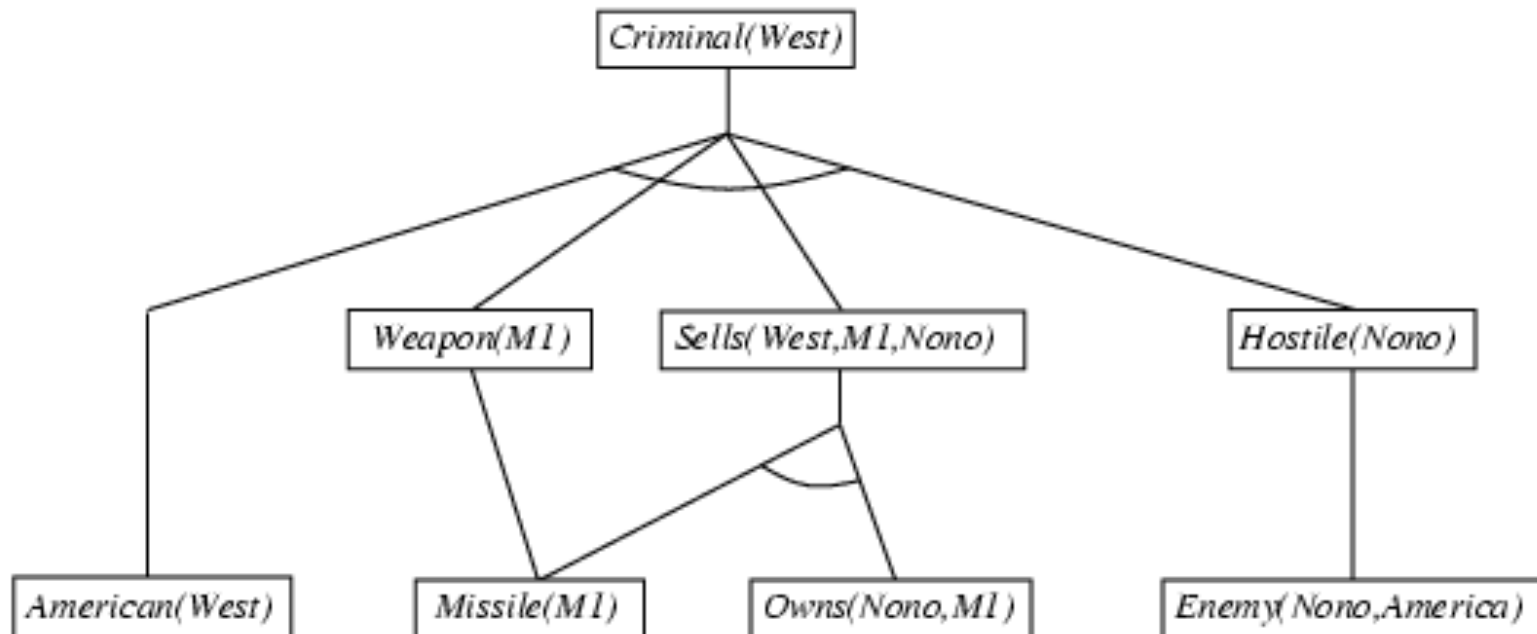

**American(x) \wedge Weapon(y) \wedge Sells(x,y,z) \wedge Hostile(z) \Rightarrow Criminal(x)*

**Owns(Nono,M1) and Missile(M1)*

**Missile(x) \wedge Owns(Nono,x) \Rightarrow Sells(West,x,Nono)*

**Missile(x) \Rightarrow Weapon(x)*

**Enemy(x,America) \Rightarrow Hostile(x)*

**American(West)*

**Enemy(Nono,America)*

Properties of forward chaining

- Sound and complete for first-order definite clauses
- **Datalog** = first-order definite clauses + **no functions**
- FC terminates for Datalog in finite number of iterations
- May not terminate in general if α is not entailed
- This is unavoidable: entailment with definite clauses is semidecidable

Efficiency of forward chaining

Incremental forward chaining: no need to match a rule on iteration k if a premise wasn't added on iteration $k-1$

⇒ match each rule whose premise contains a newly added positive literal

Matching itself can be expensive:

Database indexing allows $O(1)$ retrieval of known facts

– e.g., query $Missile(x)$ retrieves $Missile(M_1)$

Forward chaining is widely used in **deductive databases**

Hard matching example

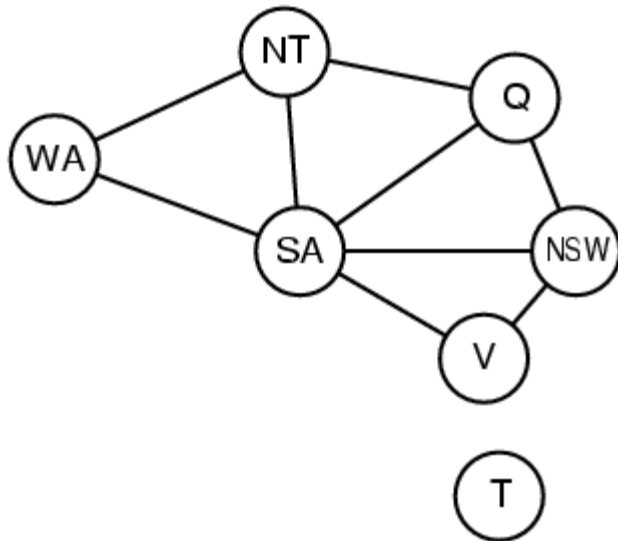

$Diff(wa,nt) \wedge Diff(wa,sa) \wedge Diff(nt,q) \wedge$
 $Diff(nt,sa) \wedge Diff(q,nsw) \wedge Diff(q,sa) \wedge$
 $Diff(nsw,v) \wedge Diff(nsw,sa) \wedge Diff(v,sa) \Rightarrow$
 $Colorable()$

$Diff(Blue,Red) \quad Diff(Blue,Green)$
 $Diff(Green,Red) \quad Diff(Green,Blue)$
 $Diff(Red,Blue) \quad Diff(Red,Green)$

- ***Colorable()* is inferred iff the CSP has a solution**
- **CSPs include 3SAT as a special case, hence matching is NP-hard**

Backward chaining example

Criminal(West)

Backward chaining example

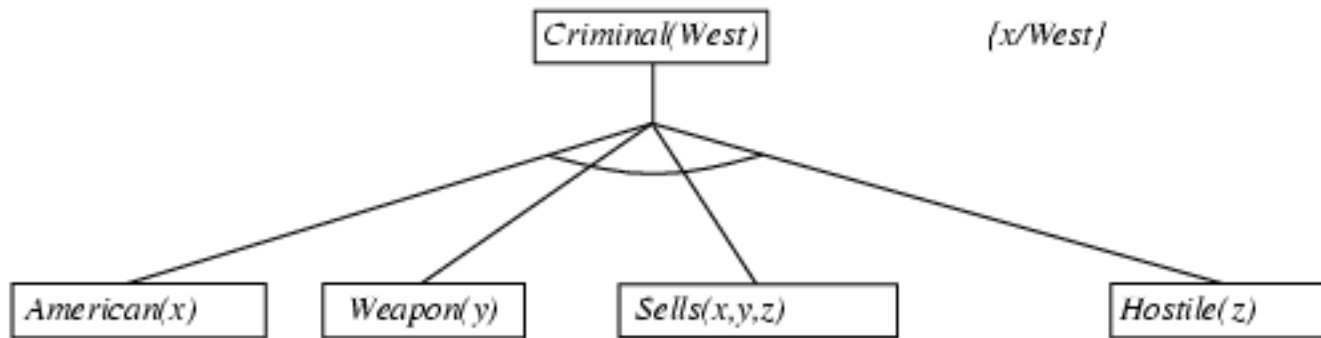

Backward chaining example

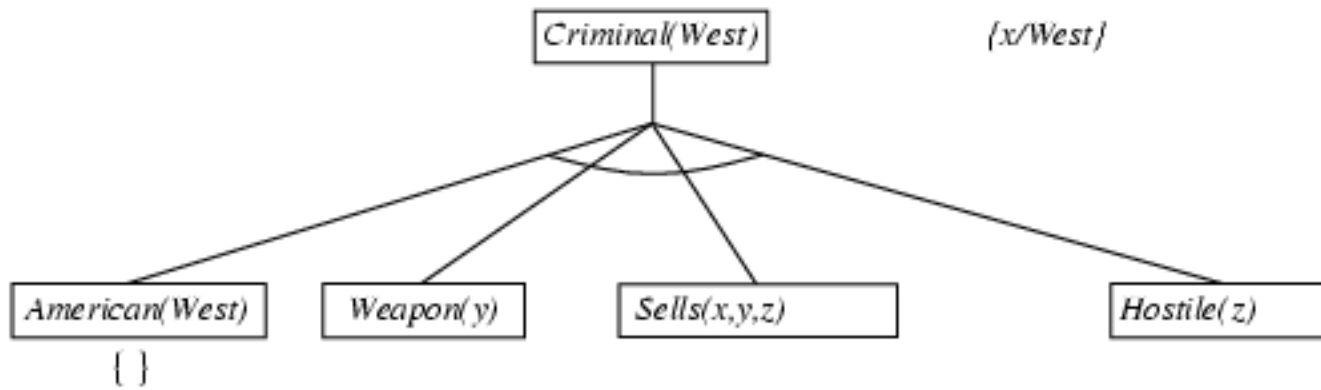

Backward chaining example

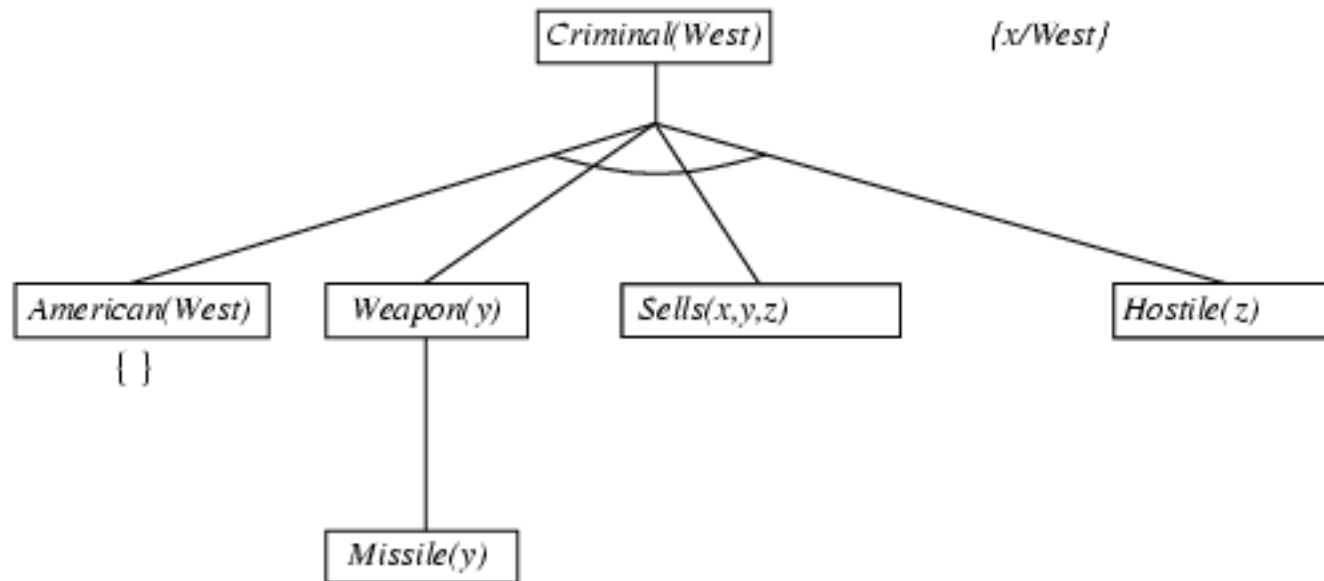

Backward chaining example

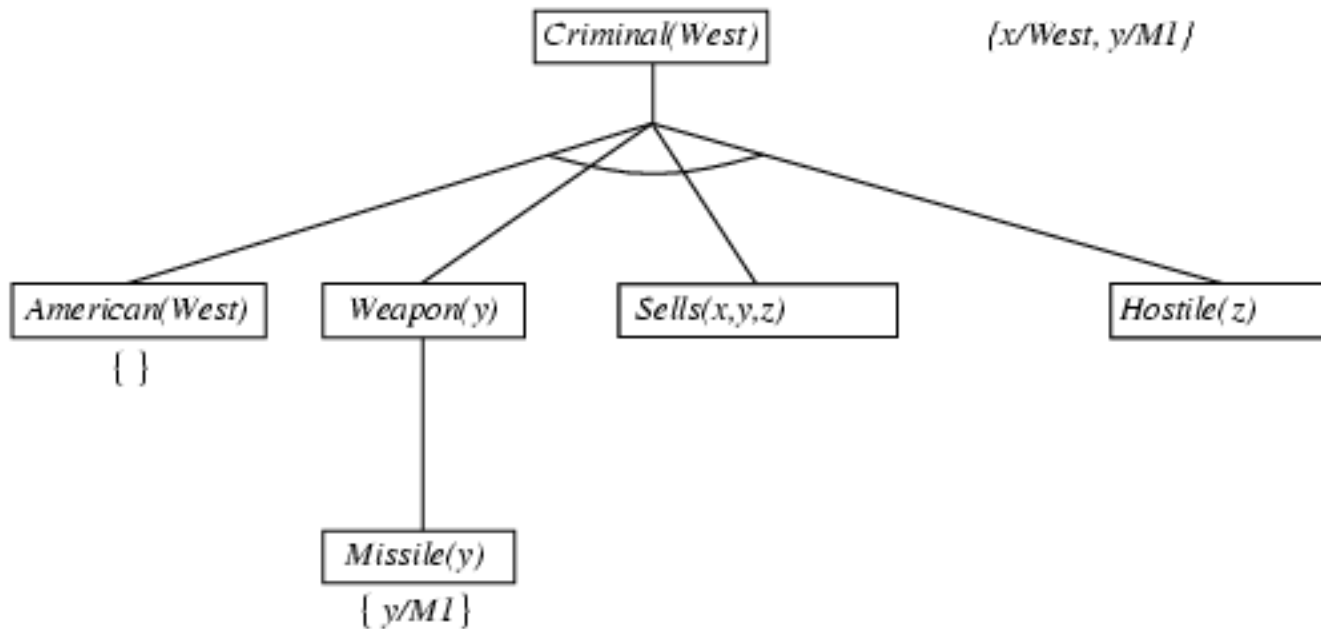

Backward chaining example

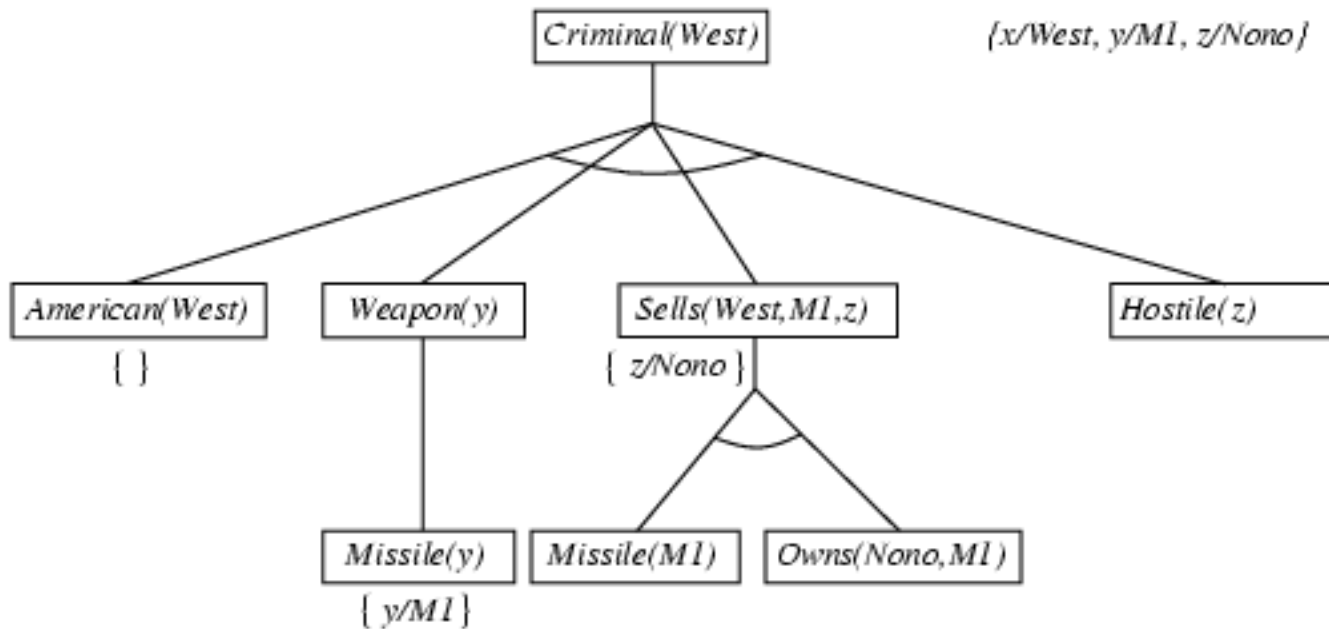

Backward chaining example

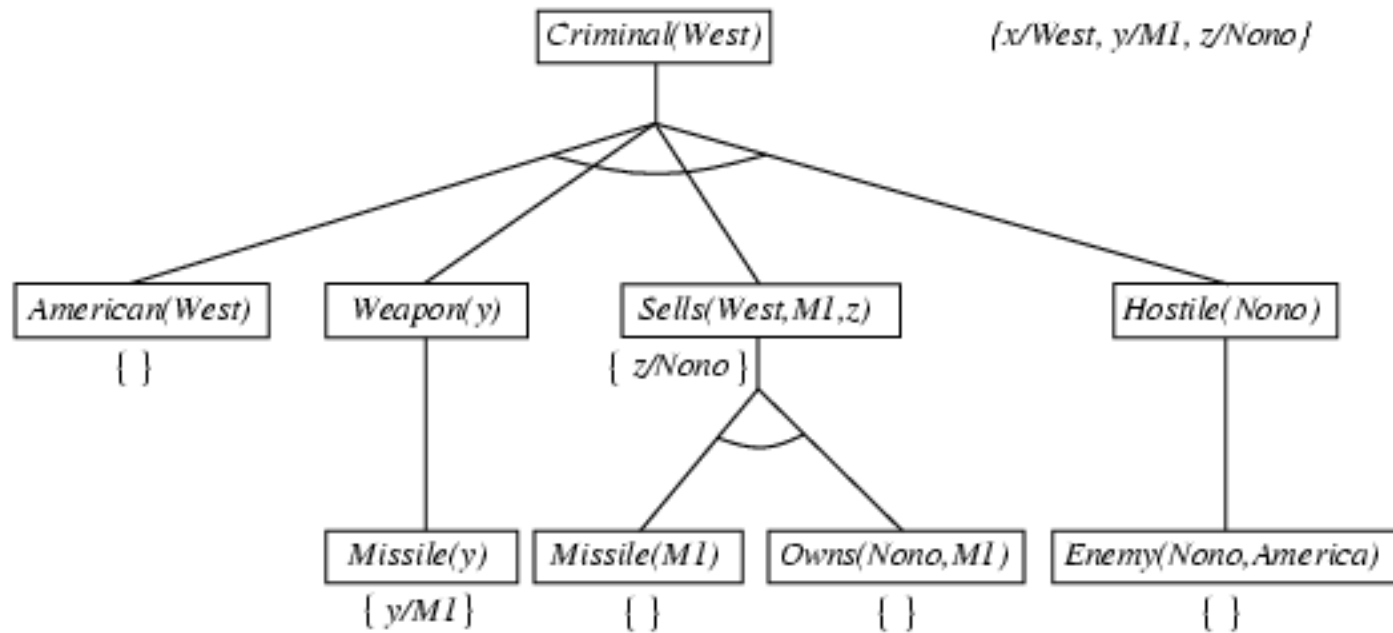

Backward chaining example

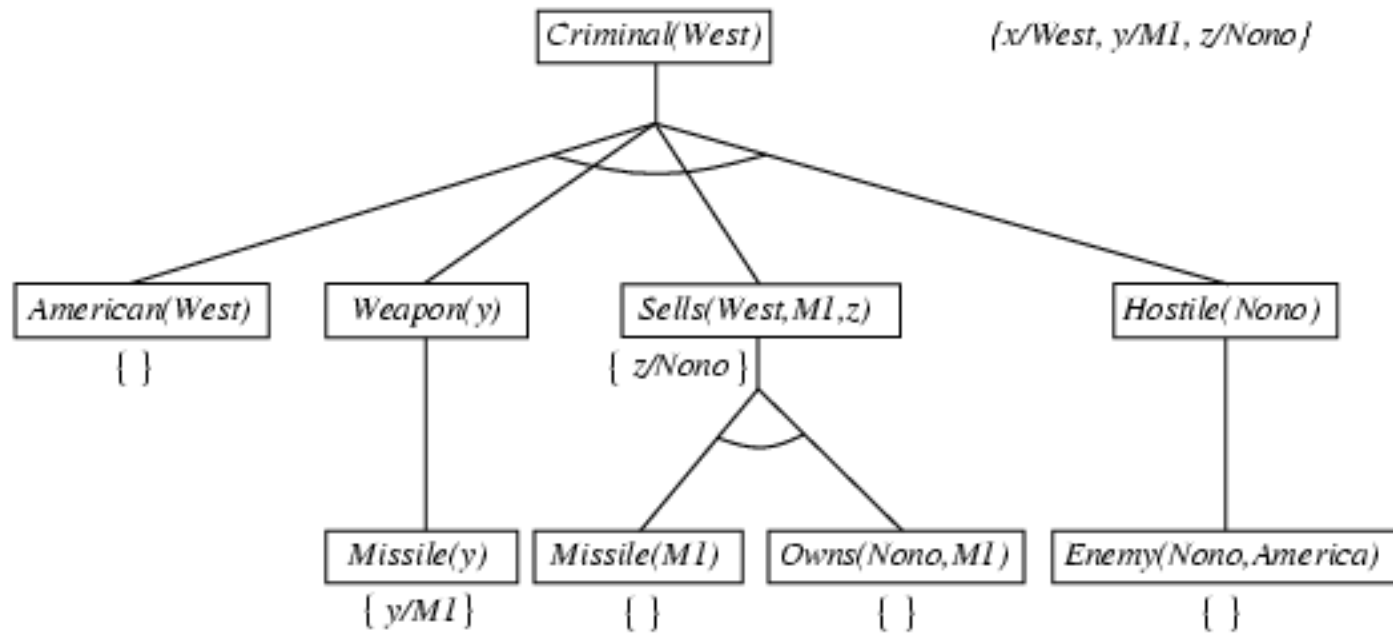

Backward chaining algorithm

```
function FOL-BC-ASK(KB, goals,  $\theta$ ) returns a set of substitutions
  inputs: KB, a knowledge base
          goals, a list of conjuncts forming a query
           $\theta$ , the current substitution, initially the empty substitution { }
  local variables: ans, a set of substitutions, initially empty

  if goals is empty then return { $\theta$ }
   $q' \leftarrow \text{SUBST}(\theta, \text{FIRST}(\textit{goals}))$ 
  for each r in KB where  $\text{STANDARDIZE-APART}(r) = (p_1 \wedge \dots \wedge p_n \Rightarrow q)$ 
    and  $\theta' \leftarrow \text{UNIFY}(q, q')$  succeeds
     $\textit{ans} \leftarrow \text{FOL-BC-ASK}(\textit{KB}, [p_1, \dots, p_n | \text{REST}(\textit{goals})], \text{COMPOSE}(\theta, \theta')) \cup \textit{ans}$ 
  return ans
```

$$\text{SUBST}(\text{COMPOSE}(\theta_1, \theta_2), p) = \text{SUBST}(\theta_2, \text{SUBST}(\theta_1, p))$$

Properties of backward chaining

- Depth-first recursive proof search: space is linear in size of proof
- Incomplete due to infinite loops
 - \Rightarrow fix by checking current goal against every goal on stack
- Inefficient due to repeated subgoals (both success and failure)
 - \Rightarrow fix using caching of previous results (extra space)
- Widely used for [logic programming](#)

Logic programming: Prolog

- Algorithm = Logic + Control
- Basis: backward chaining with Horn clauses + bells & whistles
Widely used in Europe, Japan (basis of 5th Generation project)
Compilation techniques \Rightarrow 60 million LIPS
- Program = set of clauses = head :- literal₁, ... literal_n.
`criminal(X) :- american(X), weapon(Y), sells(X,Y,Z), hostile(Z).`
- Depth-first, left-to-right backward chaining
- Built-in predicates for arithmetic etc., e.g., `X is Y*Z+3`
- Built-in predicates that have side effects (e.g., input and output)
- predicates, assert/retract predicates)
- Closed-world assumption ("negation as failure")
 - e.g., given `alive(X) :- not dead(X).`
 - `alive(joe)` succeeds if `dead(joe)` fails

Prolog

- Appending two lists to produce a third:

```
append([], Y, Y) .
```

```
append([X|L], Y, [X|Z]) :- append(L, Y, Z) .
```

- query: `append(A, B, [1, 2]) ?`

- answers: `A=[] B=[1, 2]`

```
A=[1] B=[2]
```

```
A=[1, 2] B=[]
```

Resolution: brief summary

- Full first-order version:

$$\frac{\ell_1 \vee \cdots \vee \ell_k, \quad m_1 \vee \cdots \vee m_n}{(\ell_1 \vee \cdots \vee \ell_{i-1} \vee \ell_{i+1} \vee \cdots \vee \ell_k \vee m_1 \vee \cdots \vee m_{j-1} \vee m_{j+1} \vee \cdots \vee m_n)\theta}$$

where $\text{Unify}(\ell_i, \neg m_j) = \theta$.

- The two clauses are assumed to be standardized apart so that they share no variables.
- For example,

$$\frac{\neg \text{Rich}(x) \vee \text{Unhappy}(x) \quad \text{Rich}(\text{Ken})}{\text{Unhappy}(\text{Ken})}$$

with $\theta = \{x/\text{Ken}\}$

- Apply resolution steps to $\text{CNF}(\text{KB} \wedge \neg\alpha)$; complete for FOL

Conversion to CNF

- Everyone who loves all animals is loved by someone:
 $\forall x [\forall y \text{ Animal}(y) \Rightarrow \text{Loves}(x,y)] \Rightarrow [\exists y \text{ Loves}(y,x)]$

- 1. Eliminate biconditionals and implications

$$\forall x [\neg \forall y \neg \text{Animal}(y) \vee \text{Loves}(x,y)] \vee [\exists y \text{ Loves}(y,x)]$$

- 2. Move \neg inwards: $\neg \forall x p \equiv \exists x \neg p$, $\neg \exists x p \equiv \forall x \neg p$

$$\forall x [\exists y \neg (\neg \text{Animal}(y) \vee \text{Loves}(x,y))] \vee [\exists y \text{ Loves}(y,x)]$$

$$\forall x [\exists y \neg \neg \text{Animal}(y) \wedge \neg \text{Loves}(x,y)] \vee [\exists y \text{ Loves}(y,x)]$$

$$\forall x [\exists y \text{ Animal}(y) \wedge \neg \text{Loves}(x,y)] \vee [\exists y \text{ Loves}(y,x)]$$

Conversion to CNF contd.

3. Standardize variables: each quantifier should use a different one

$$\forall x [\exists y \textit{Animal}(y) \wedge \neg \textit{Loves}(x,y)] \vee [\exists z \textit{Loves}(z,x)]$$

4. Skolemize: a more general form of existential instantiation.
Each existential variable is replaced by a **Skolem function** of the enclosing universally quantified variables:

$$\forall x [\textit{Animal}(F(x)) \wedge \neg \textit{Loves}(x,F(x))] \vee \textit{Loves}(G(x),x)$$

5. Drop universal quantifiers:

$$[\textit{Animal}(F(x)) \wedge \neg \textit{Loves}(x,F(x))] \vee \textit{Loves}(G(x),x)$$

6. Distribute \vee over \wedge :

$$[\textit{Animal}(F(x)) \vee \textit{Loves}(G(x),x)] \wedge [\neg \textit{Loves}(x,F(x)) \vee \textit{Loves}(G(x),x)]$$

Example knowledge base contd.

... it is a crime for an American to sell weapons to hostile nations:

$American(x) \wedge Weapon(y) \wedge Sells(x,y,z) \wedge Hostile(z) \Rightarrow Criminal(x)$

Nono ... has some missiles, i.e., $\exists x Owns(Nono,x) \wedge Missile(x)$:

$Owns(Nono,M_1)$ and $Missile(M_1)$

... all of its missiles were sold to it by Colonel West

$Missile(x) \wedge Owns(Nono,x) \Rightarrow Sells(West,x,Nono)$

Missiles are weapons:

$Missile(x) \Rightarrow Weapon(x)$

An enemy of America counts as "hostile":

$Enemy(x,America) \Rightarrow Hostile(x)$

West, who is American ...

$American(West)$

The country Nono, an enemy of America ...

$Enemy(Nono,America)$

Resolution proof: definite clauses

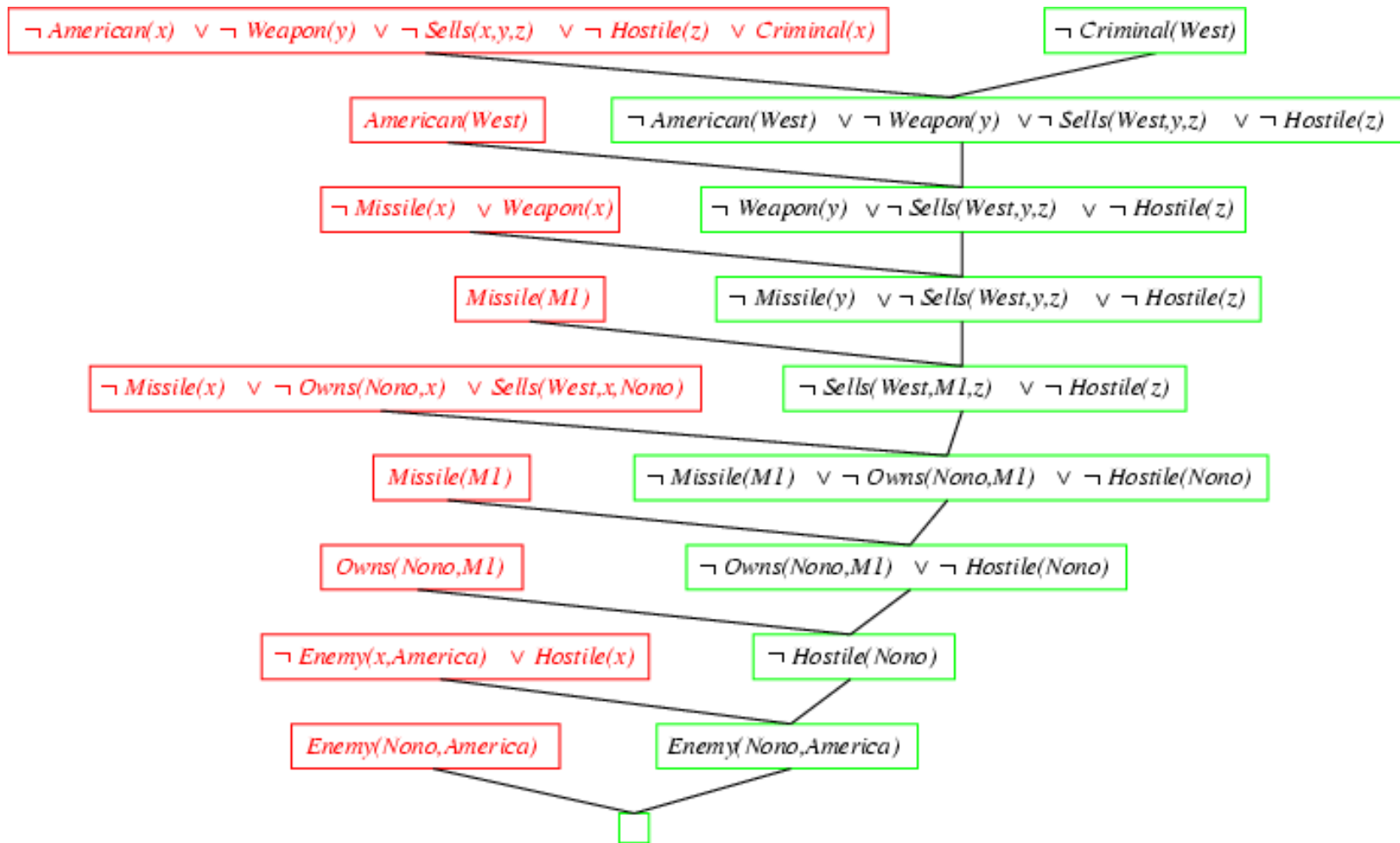

Converting to clause form

$$\forall x, y P(x) \wedge P(y) \wedge I(x,27) \wedge I(y,28) \rightarrow S(x, y)$$

$$P(A), P(B)$$

$$I(A,27) \vee I(A,28)$$

$$I(B,27)$$

$$\neg S(B, A)$$

Prove $I(A,27)$

Example: Answer Extraction

